



# Parts Manual

Mfg. No: 020605-00  
3,000 PSI Troy-Bilt



---

Model Components	Page
Main Unit (80012013).....	4
Pump (80011010).....	6
Torque Specification Chart.....	8

Not For  
Reproduction

# Main Unit (80012013)

Note: Unless noted otherwise, use the standard torque specifications

Mfg. No: 020605-00

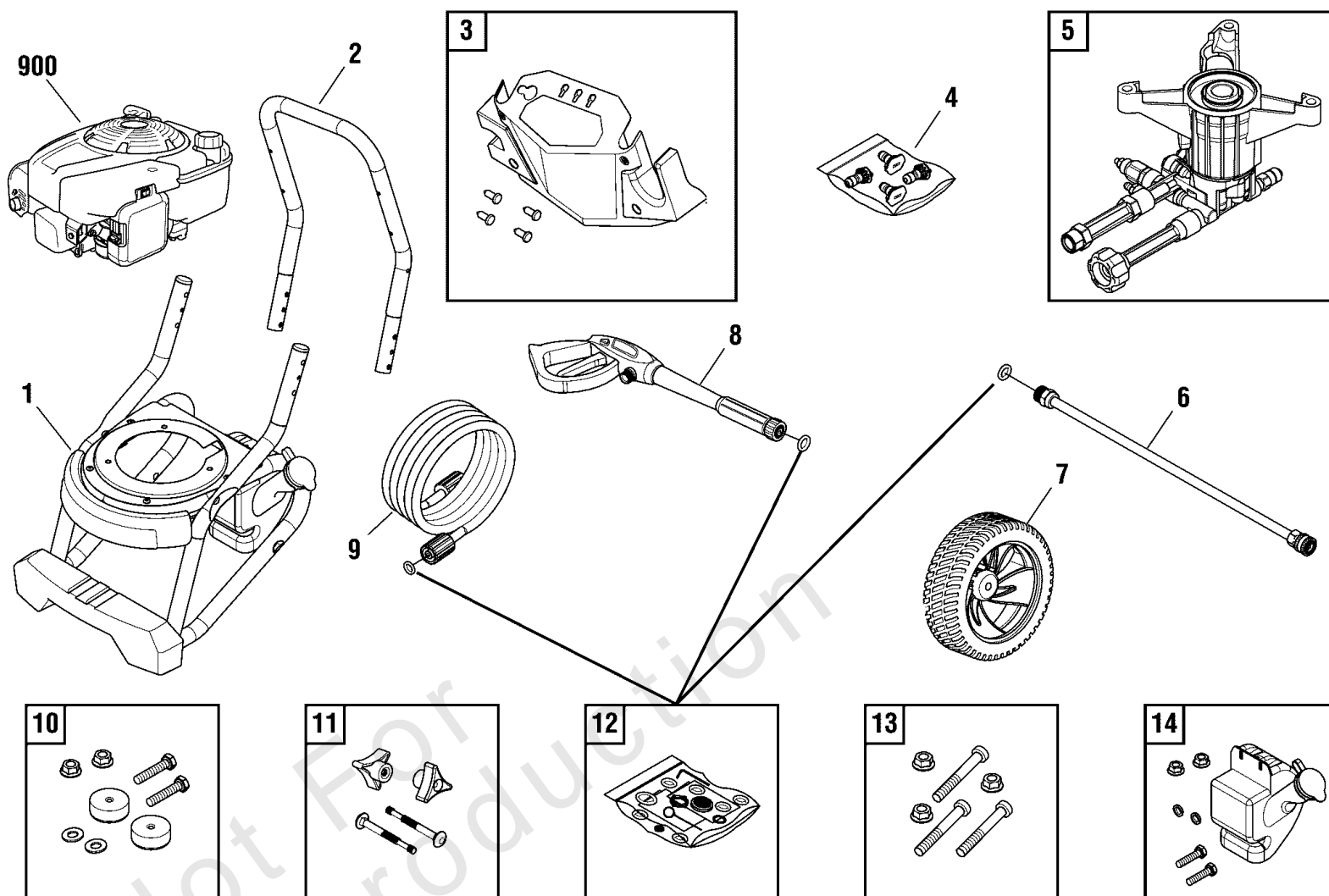

## Main Unit (80012013)

REF NO	PART NO	QTY	DESCRIPTION
1	315745GS		BASE
2	310629BVGS		HANDLE
3	706606		BILLBOARD
--	195964GS		CLIP
4	707478		KIT-QC NOZZLES
--	195983AJGS		NOZZLE, QC RED
--	195983TGS		NOZZLE-QC YELLOW
--	707480		NOZZLE-QC WHITE
--	198841GS		NOZZLE-QC BLACK
5	706607		PUMP
--	B2384GS		FILTER
--	208673GS		VALVE-THERMAL RELIEF
6	706595		EXTENSION-QC
7	313837GS		WHEEL
8	319853GS		GUN
9	196006GS		HOSE
10	192310GS		MOUNT-VIBRATION
11	311896GS		KIT-HARDWARE HANDLE
12	705001		KIT-O-RINGS
13	315139GS		KIT-HARDWARE PUMP MOUNTING
14	315914GS		TANK-CHEMICAL
--	312369GS		CAP-CHEMICAL TANK
900			* ENGINE
--	317999GS		OIL -(Not Illustrated)
--	23139GS		KEY -(Not Illustrated)
--	315543GS		PUSHNUT -(Not Illustrated)
--	22304GS		WASHER -(Not Illustrated)
--	208538GS		DECAL-WARNING SPARK -(Not Illustrated)
--	311281GS		DECAL-WARNING TANK -(Not Illustrated)
--	705076		HOSE-CHEMICAL -(Not Illustrated)
--	314957GS		AXLE -(Not Illustrated)
--	705854		TAG-WARNING -(Not Illustrated)
--	705853		TAG-QUICKSTART -(Not Illustrated)
--	6039		PUMP SAVER -(Optional Accessory - Not Included)

### Footnotes:

\* Contact Engine Manufacturer for parts & service.

# Pump (80011010)

Note: Unless noted otherwise, use the standard torque specifications

Mfg. No: 020605-00

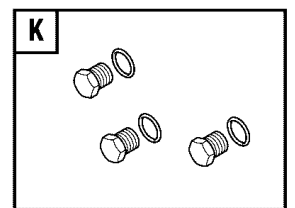
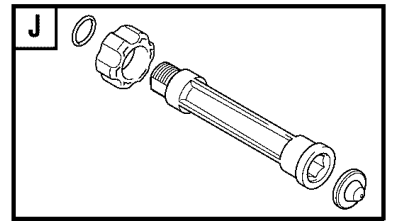
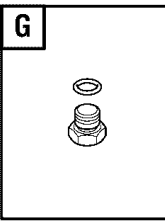
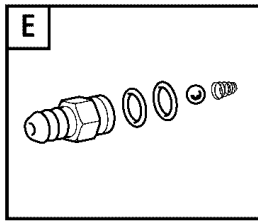
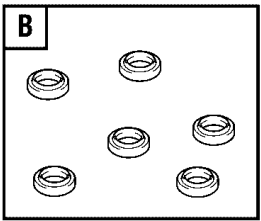
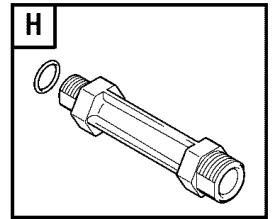
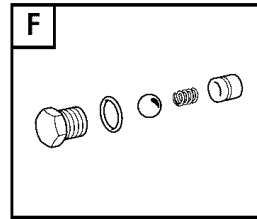
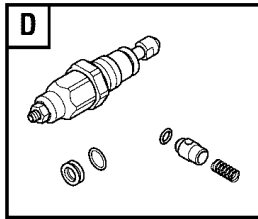
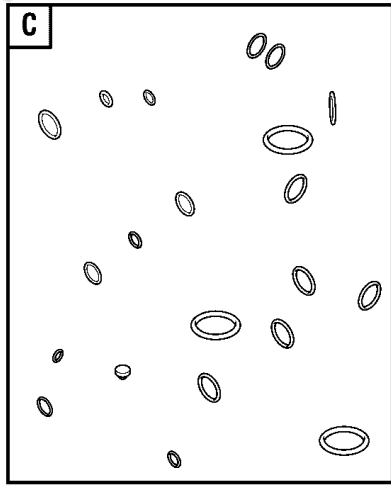
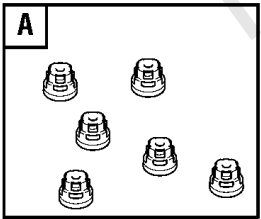
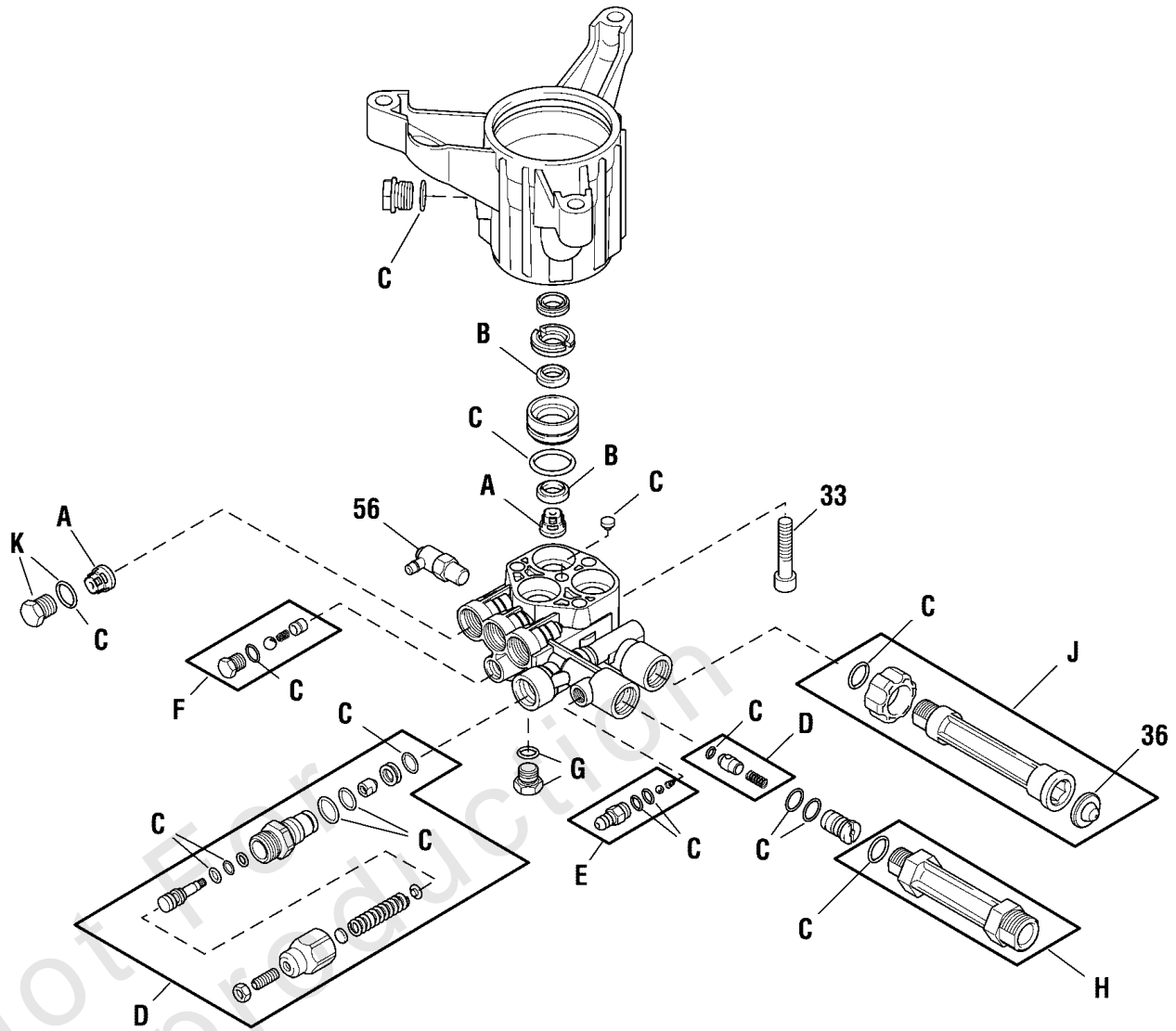

## Pump (80011010)

REF NO	PART NO	QTY	DESCRIPTION
33	204087GS		SCREW
36	B2384GS		FILTER-GARDEN HOSE
56	208673GS		VALVE-THERMO RELIEF
A	317897GS		* KIT-CHECK VALVE
B	204084GS		* KIT-WATER SEAL
C	706619		* KIT-O-RING
D	706610		* KIT-UNLOADER
E	317787GS		* KIT-CHEMICAL INJ
F	317788GS		* KIT-EASY START
G	200350GS		* SCREW-GRUB
H	201497GS		* FITTING
J	201496GS		* KIT-WATER INLET
K	706780		* KIT-PLUG
--	6039		PUMP SAVER -(Optional Accessory - Not Included)

Not For  
Reproduction

---

**Footnotes:**

\* Service Kit includes all parts shown in box.

# Hardware Identification & Torque Specifications

Torque Specification Chart								
FOR STANDARD METRIC MACHINE HARDWARE (Tolerance ± 20%)								
Property Class	5.6		8.8		10.9		12.9	
	Class 5.6		Class 8.8		Class 10.9		Class 12.9	
Size Of Hardware	in/lbs	Nm.	in/lbs	Nm.	in/lbs	Nm.	in/lbs	Nm.
	ft/lbs		ft/lbs		ft/lbs		ft/lbs	
M3	5.88	.56	13.44	1.28	19.2	1.80	22.92	2.15
M4	13.44	1.28	30.72	2.90	43.44	4.10	52.56	4.95
M5	26.4	2.50	60.96	5.75	5.97	8.10	7.15	9.7
M6	44.64	4.3	7.3	9.9	10.3	14	12.1	16.5
M7	5.2	7.1	12.1	16.5	16.9	23	19.9	27
M8	7.7	10.5	17.7	24	25	34	29	40
M10	15	21	35	48	50	67	59	81
M12	26	36	61	83	86.2	117	103	140
M14	42	58	101	132	136	185	162	220
M16	64	88	147	200	210	285	250	340
M18	89	121	202	275	287	390	346	470
M20	126	171	290	390	405	550	486	660
M22	169	230	390	530	559	745	656	890
M24	217	295	497	375	708	960	840	1140
M27	320	435	733	995	1032	1400	1239	1680
M30	435	590	995	1350	1401	1900	1681	2280
M33	590	800	1349	1830	1902	2580	2278	3090
M36	759	1030	1740	2360	2441	3310	2935	3980
M39	988	1340	2249	3050	3163	4290	3798	5150

Torque Specification Chart						
FOR STANDARD MACHINE HARDWARE (Tolerance ± 20%)						
Hardware Grade	No Marks		SAE Grade 5		SAE Grade 8	
	SAE Grade 2		SAE Grade 5		SAE Grade 8	
Size Of Hardware	in/lbs	Nm.	in/lbs	Nm.	in/lbs	Nm.
	ft/lbs		ft/lbs		ft/lbs	
8-32	19	2.1	30	3.4	41	4.6
8-36	20	2.3	31	3.5	43	4.9
10-24	27	3.1	43	4.9	60	6.8
10-32	31	3.5	49	5.5	68	7.7
1/4-20	66	7.6	8	10.9	12	16.3
1/4-28	76	8.6	10	13.6	14	19.0
5/16-18	11	15.0	17	23.1	25	34.0
5/16-24	12	16.3	19	25.8	29	34.0
3/8-16	20	27.2	30	40.8	45	61.2
3/8-24	23	31.3	35	47.6	50	68.0
7/16-14	30	40.8	50	68.0	70	95.2
7/16-20	35	47.6	55	74.8	80	108.8
1/2-13	50	68.0	75	102.0	110	149.6
1/2-20	55	74.8	90	122.4	120	163.2
9/16-12	65	88.4	110	149.6	150	204.0
9/16-18	75	102.0	120	163.2	170	231.2
5/8-11	90	122.4	150	204.0	220	299.2
5/8-18	100	136	180	244.8	240	326.4
3/4-10	160	217.6	260	353.6	386	525.0
3/4-16	180	244.8	300	408.0	420	571.2
7/8-9	140	190.4	400	544.0	600	816.0
7/8-14	155	210.8	440	598.4	660	897.6
1-8	220	299.2	580	788.8	900	1,244.0
1-12	240	326.4	640	870.4	1,000	1,360.0

The guides and ruler furnished below are designed to help you select the appropriate hardware.



Nut, M8

Thread Diameter (mm)

Inside Diameter (in)      Threads per inch

Nut, 1/2-16



Screw, M8- 1.25 x 25

Thread Diameter (mm)      Distance between threads (mm)      Body Length (mm)

Body Diameter      Threads per inch      Body Length (in)

Screw, 1/2- 16 x 2



## Standard Hardware Sizing

When a washer or nut is identified as 1/2" (M8), this is the *Nominal size*, meaning the *inside diameter* is 1/2 inch (8mm metric thread diameter); if a second number is present it represents the *threads per inch* (distance between threads).

When bolt or capscrew is identified as 1/2 - 16 x 2" (M8 - 1.25 x 50), this means the *Nominal size*, or body diameter is 1/2 inch (8mm metric thread diameter), the second number, 16, represents the *threads per inch*, (*distance between threads*). The final number is the body length of the bolt or screw, 2 inches (50mm).

## NOTES

- These torque values are to be used for all hardware excluding: locknuts, self-tapping screws, thread forming screws, sheet metal screws and socket head setscrews.
- Recommended seating torque values for locknuts:
  - for prevailing torque locknuts - use 65% of grade 5 torques.
  - for flange whizlock nuts and screws - use 135% of grade 5 torques.
- Unless otherwise noted on assembly drawings, all torque values must meet this specification.

## Common Hardware Types

Hex Head Capscrew

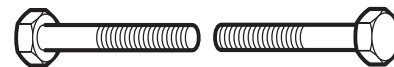

Washer



Carriage Bolt

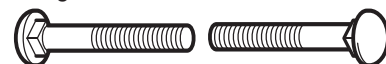

Hex Nut

## Wrench & Fastener Size Guide

1/4" Bolt or Nut Wrench—7/16"	5/16" Bolt or Nut Wrench—1/2"	3/8" Bolt or Nut Wrench—9/16"	7/16" Bolt or Nut Wrench (Bolt)—5/8" Wrench (Nut)—11/16"	1/2" Bolt or Nut Wrench—3/4"
M6 Bolt or Nut Wrench—10mm	M8 Bolt or Nut Wrench—13mm	M10 Bolt or Nut Wrench—17mm	M12 Bolt or Nut Wrench—19mm	M14 Bolt or Nut Wrench—22mm



